

Products Related to Common Sockets and DIN Tracks

CSM_common_sockets_DS_E_3_1

A Wide Variety of Square and Round Sockets in Front-mounting and Back-mounting Models

- Models available with finger protection.
- Hold-down Clips and Socket Bridges for PYF Sockets are also available.
- New screwless models available.

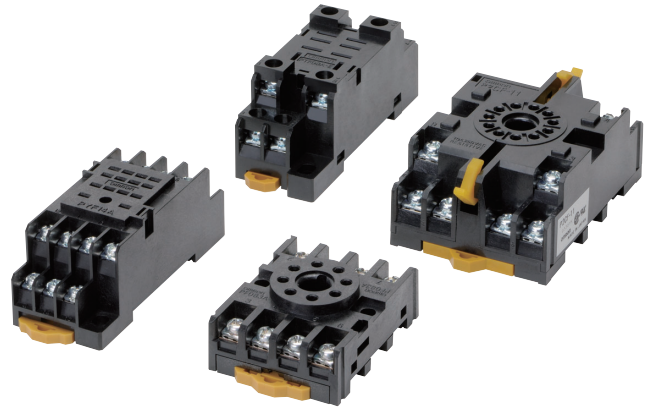

Models Used with Common Sockets

Sockets

Item		Model	Number of pins	Applicable Sockets			
				Front-mounting	Back-mounting		
Proximity Sensors	E2C	E2C-AM4A	8	P2CF-08	P3G		
		E2C-AK4A	11	P2CF-11	P3GA		
		E2C-GE4A E2C-GF4A	8	PYF08A	PY		
Level Devices	61F	61F-GP-N8 61F-APN2	8	PF083A	PL		
		61F-UHS		8PFA1			
		61F-HSL		8PFA			
		61F-03B, -04B 61F-GP-N 61F-GPN-V50 61F-GPN-BT/BC	11	PF113A			
		61F-IP 61F-G1P, -G2P	14	14PFA			
		K7L	8	P2RF-08(-E)		---	
	General-purpose Relays and Solid-state Relays	MY (Q, K, H)	MY1, MY2	8		PYF	PY
			MY3	11			
			MY4, MYQ4 MY4Z-CBG MY2K, MY4H	14			
			LY1, LY2	8			
LY3		11					
LY4		14					
G7K		G7K-412S	14	---			
G2A(K)		G2A, G2A-434 G2AK	14	PYF	PY		
MK(K)		MK2P	8	PF083A(-E)	PL		
		MK3P MK2KP	11	PF113A(-E)			

Item		Model	Number of pins	Applicable Sockets			
				Front-mounting	Back-mounting		
General-purpose Relays and Solid-state Relays	MM	MM2(X)P	8	8PFA	PL		
		MM3P MM2(X)KP	11	PFA			
		MM3XP MM3(X)KP MM4(X)P MM4(X)KP	14				
		G4Q	---			8PFA1	
		G3F	G3F(D) Series G3FM			8	PYF
		G3H	G3H(D) Series	8		PTF	PT
	G3B	G3B(D) Series	8	PF083A	PL		
	G9H	G9H-2□□S	8	PTF	PT		
	G2R	G2R-1-S□	5	P2RF-05□	P2R-05□		
		G2R-2-S□	8	P2RF-08□	P2R-08□		
	G3R	---	5	P2RF-05□	P2R-05□		
	G7T G3TA	G7T G3TA	5	P7TF-05	---		
	G7S	G7S-4A2B-E G7S-3A3B-E	14	P7S-14F-END	P7S-14P-E		
		G7SA	G7SA-3A1B G7SA-2A2B	10	P7SA-10F P7SA-10F-ND	P7SA-10P	
			G7SA-5A1B G7SA-4A2B G7SA-3A3B	14	P7SA-14F P7SA-14F-ND	P7SA-14P	
	Timers	H3CA	H3CA-8(H)	8	P2CF	P3G PL	
			H3CA-A	11		P3GA PL	
H5CN		H5CN-□M	11	P3GA			
		Other H5CN models	8	P3G			
H5CX		H5CX-L8□	8	P3G			
		H5CX-A11□	11	P3GA			
H5CZ		H5CZ-L8□	8	P3G			

Products Related to Common Sockets and DIN Tracks

Group name	Item	Model	Number of pins	Applicable Sockets	
				Front-mounting	Back-mounting
Timers	H3CR	H3CR-A8□ H3CR-F8□ H3CR-G8□ H3CR-H8□	8	P2CF	P3G PL
		H3CR-A H3CR-AS H3CR-AP H3CR-F H3CR-FN H3CR-HRL	11		P3GA PL
	H3M	---	8	PF085A	P3G PL
	H3Y	H3Y-2	8	PYF	PY
		H3Y-4	14		
	H3YN	H3YN-2□	8		
		H3YN-4□	14		
	H3RN	H3RN-1□	5	P2RF-□-E	P2R □-□7P
		H3RN-2□	8		
	RD2P	---	8	8PFA1	PL
H2C	---	8	P2CF PF085A	P3G PL	
Counters	H7CX	H7CX-A11□	11	P2CF	P3GA
	H7CZ	H7CZ-L8□	8		P3G
	H7CN	H7CN-□M	11		P3GA
		Other H7CN models	8		P3G
E5CN	E5CN-□U	11	P3GA		
E5C2	---	8	P3G		
E5CS	E5CS-□1, □2	11	P3GA		
	Other E5CS models	8	P3G		
E5L	---	14	PTF14A		---
Signal Converters	K3FK	K3FK models not listed below	8		8PFA (Included with Converter)
		K3FK-G□ K3FK-GS□ K3FK-SL-75-□	11	11PFA (Included with Converter)	
Component Protective Components	SE	SE-KP□N	8	8PFA1	---
	SAO	SAO-□		---	
	APR	APR-S		PF083A	PL08
	K2CU	APR-S380/-S440	11	P2CF-11	PL11
		K2CU-P	8	8PFA1	---
	SDV	SDV-F□□-FH□□	14	14PFA	PL08
		SDV-D□□			PL15
LG2	LG2-□	8	PF083A	PL08	
K6EL	K6EL-□	11	P2CF-11	PL11 and P3GA-11	
Products for High-voltage Power Receiving Equipment	AGF	AGF-1-P5	8	8PFA1	---
Annunciators	MYA	MYA-NA1, -NB1	8	PF083A	PL
		MYA-NA2, -NB2 MYA-LA1, -LB1 MYA-LA2, -LB2 MYA-LA12, -LB12	11	PF113A	

Hold-down Clips For Square Sockets

Sockets	PYF□A PTF□A	PYF08M	PY□(QN) PT□(QN)	PY□-02 PT□-0
Applicable models	MY□, MY□N, MY□-D, MY2□-CR, MY4□-CR, MY4Z□-CR, MY□-TU, MY2K, MY□N-D2, LY□, LY□N, LY□-TU, MY□□, G3H(D) Series, G3F(D) Series, G3FM, and G9H	PYC PYC-P	PYC-P PYC-S	PYC-P
MY□ * LY□	---	---	PYC-P2	
MY4H	---	---	PYC-P	
MY2Z□-CR MY3□-CR LY□-CR	Y92H-3	---	PYC-1	
G2A(K) Series	PYC-A2	---	PYC-2 PYC-3 PYC-5	PYC-3 PYC-5
G7K	PKC	---	---	
H3Y	Y92H-3	---	Y92H-4	

Note: The □ in the model number is replaced with 08, 11, or 14.
* If you use a Hold-down Clip with the MY2I, you cannot use the PYF08A.
Use the PYF14A.

For Round Sockets

Sockets	PF083A PF113A	PL08 (-Q) PL11 (-Q)	PLE08-0 PLE11-0	P2CF-11
Applicable models	PFC-A1	PLC	PLC-10	---
61F-03B, -04B	PFC-N8	PHC-5		
61F-GP-N, -GPN-BT 61F-GP-N8 ?61F-APN2	PFC-A1	PLC		
MK2P Series, MK2KP, MK3P□(-US), and G3B(D) Series	PFC-A1	PLC-1	---	
MK3ZP MK3LP	PFC-A6	PLC-7	---	---
MYA-NA1, -NB1 MYA-LA1, -LB1 MYA-NA2, -NB2 MYA-LA2, -LB2	PFC-A6	PLC-7	---	---
MYA-LA12, -LB12	PFC-A7	PLC-8	---	---
APR-S	PFC-A6	PLC-7	---	---
APR-S380/-S440	---	---	---	Y92H-1
LG2	PFC-A7	PLC-8	---	---
K6EL	---	Y92H-1	---	---

Note: 1. The 8PFA(1), 11PFA, and 14PFA are held with hooks.
2. The PL15, PL20, and PF202, as well as models not given in the above table, require panel processing for installation.
3. The PF085A Hold-down Clip is included with the H3M and H2A. It is an option (sold separately) for the H2C.

Products Related to Common Sockets and DIN Tracks

Ordering Information

Square Sockets

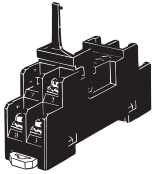
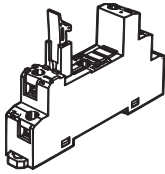
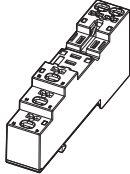
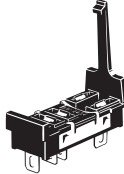
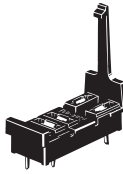
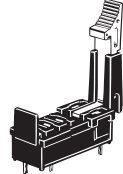
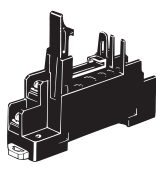
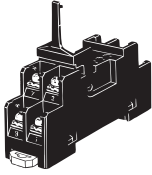
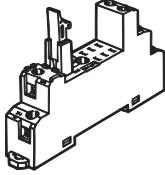
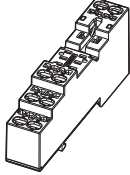
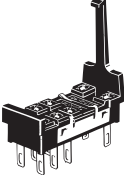
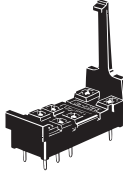
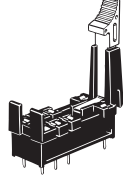
Model	P2RF (front-mounting), page 9			P2R (back-mounting), pages 11 and 12			P7TF (front-mounting), page 12
				Solder terminals		PCB terminals	
5 pins	P2RF-05 Approx. 27 g 	P2RF-05-E* Approx. 38 g 	P2RF-05-S Approx. 36 g 	P2R-05A Approx. 5 g 	P2R-05P Approx. 5 g 	P2R-057P Approx. 5.5 g 	P7TF-05 Approx. 28 g 
8 pins	P2RF-08 Approx. 33 g 	P2RF-08-E* Approx. 38 g 	P2RF-08-S Approx. 40 g 	P2R-08A Approx. 5 g 	P2R-08P Approx. 5 g 	P2R-087P Approx. 5.5 g 	—











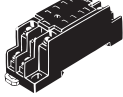
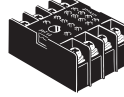
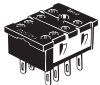
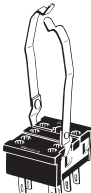
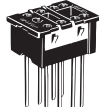
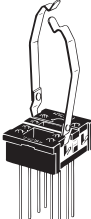

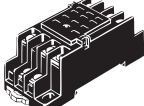
Note: 1. The structure of □-E models provides finger protection. Round terminals cannot be used. Use forked crimp terminals.

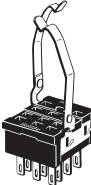
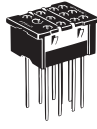
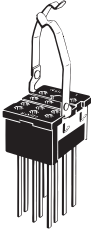
2. To remove the Relay, pull the lever on the Socket with your fingers supporting the lever and the opposite side of the Relay case, and jiggle the Relay.

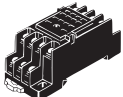
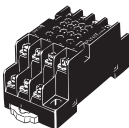
* Use a #1 Phillips screwdriver to tighten the screws on this Socket.



Minimum Order Lot The following models are available at the minimum order lot specified below.

Number of pins	Model	P2RF	P2R		P7TF	Minimum order lot (pcs)
5 pins		P2RF-05	P2R-05A	P2R-05P	P7TF-05	10
8 pins		P2RF-08	P2R-08A	P2R-08P	---	

Model	PYF (front-mounting), page 14		PY (back-mounting), page 15				
			Solder terminals		Wrapping terminals		PCB terminals
8 pins	PYF08A Approx. 32 g 	PYF08M Approx. 26 g 	PY08 Approx. 8 g 	PY08-Y1 PY08-Y3 	PY08QN Approx. 12 g PY08QN2 	PY08QN-Y1 PY08QN2-Y1 	PY08-02 *2 Approx. 7.2 g 
11 pins	PYF11A Approx. 43 g 		PY11 Approx. 9 g 	PY11-Y1 	PY11QN PY11QN2 	PY11QN-Y1 PY11QN2-Y1 	PY11-02 *2 
14 pins	PYF14A Approx. 49 g 	PYF14T Approx. 53 g 	PY14 Approx. 10 g 	PY14-Y1 PY14-Y3 	PY14QN Approx. 14 g PY14QN2 	PY14QN-Y1 PY14QN2-Y1 PY14QN-Y3 PY14QN2-Y3 	PY14-02 *2 

Products Related to Common Sockets and DIN Tracks

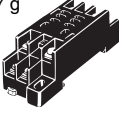
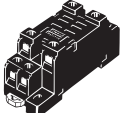
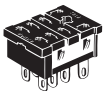
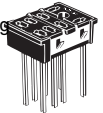
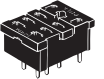
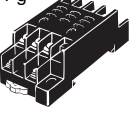
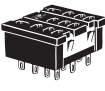
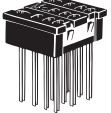
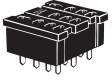
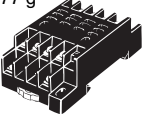
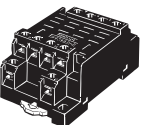
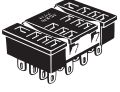
Note: 1. The structure of □-E models provides finger protection. Round terminals cannot be used. Use forked crimp terminals.
2. Refer to Models with Standards Certification for detailed information on the models of Common Sockets that are certified for standards.
 *1. Use a #1 Phillips screwdriver to tighten the screws on this Socket.
 *2. The structure does not resist flux. Manual soldering is recommended for this product.

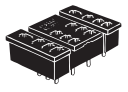
Model Number of pins	PTF (front-mounting), page 17		PT (back-mounting), page 18		
			Solder terminals	Wrapping terminals	PCB terminals
8 pins	PTF08A Approx. 47 g 	PTF08A-E *1 	PT08 Approx. 11 g 	PT08QN Approx. 10.4 g 	PT08-0 *2 Approx. 8 g 
11 pins	PTF11A Approx. 61 g 		PT11 Approx. 13 g 	PT11QN 	PT11-0 *2 Approx. 12.2 g 
14 pins	PTF14A Approx. 77 g 	PTF14A-E *1 	PT14 Approx. 17 g 	PT14QN Approx. 20 g 	PT14-0 *2 Approx. 16.2 g 



Note: The structure of □-E models provides finger protection. Round terminals cannot be used. Use forked crimp terminals.
 * Use a #1 Phillips screwdriver to tighten the screws on this Socket.
 * The structure does not resist flux. Manual soldering is recommended for this product.

Minimum Order Lot

The following models are available at the minimum order lot specified below.

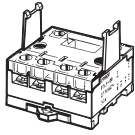
Number of pins	Model	PYF	PY	PTF	PT	Minimum order lot (pcs)
8 pins		PYF08A PYF08M	PY08	PTF08A	PT08	10
11 pins		PYF11A	PY11	PTF11A	PT11	
14 pins		PYF14A	PY14	PTF14A	PT14	

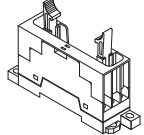

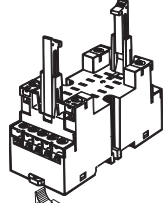
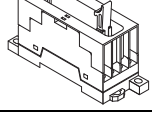
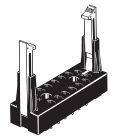
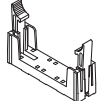







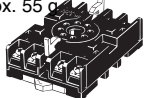
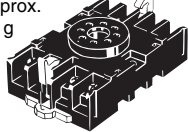
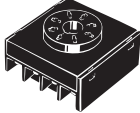

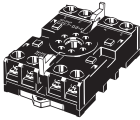
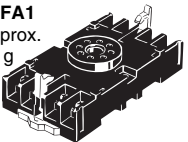

Model Number of pins	P7LF (front-mounting), page 20
6 pins	P7LF-06 Approx. 60 g 

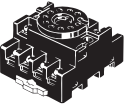
Model Number of pins	P7S/P7SA, pages 20 and 21	
	Front-mounting	PCB terminals
10 pins	P7SA-10F Approx. 44 g P7SA-10F-ND Approx. 44 g 	P7SA-10P Approx. 9 g 
14 pins	P7S-14F-END Approx. 110 g  P7SA-14F Approx. 59 g P7SA-14F-ND Approx. 59 g 	P7S-14P-E Approx. 25 g  P7SA-14P Approx. 10 g 

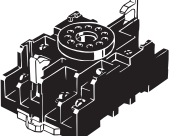
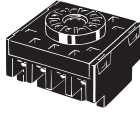
Note: Refer to *Models with Standards Certification* for detailed information on the models of Common Sockets that are certified for standards.

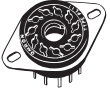
Products Related to Common Sockets and DIN Tracks

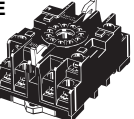
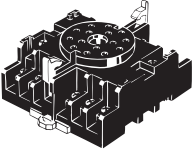
Round Sockets

Model Number of pins	PF (front-mounting), page 23	P2CF (front-mounting), page 24	PFA (front-mounting), page 25	P3G (back-mounting), page 26	PL (back-mounting), page 27		
					Solder terminals	Wrapping terminals	PCB terminals
8 pins	PF083A Approx. 34 g 	P2CF-08 Approx. 55 g 	8PFA Approx. 57 g 	P3G-08 Approx. 40 g 	PL08 Approx. 14 g 	PL08-Q Approx. 15 g 	PLE08-0 Approx. 10.6 g 
	PF083A-E * 	P2CF-08-E 	8PFA1 Approx. 66 g 	Note: The Y92A-48G Terminal Cover can be used to provide finger protection.			
	PF085A Approx. 40 g 						
11 pins	PF113A Approx. 47 g 	P2CF-11 Approx. 70 g 	11PFA Approx. 74 g 	P3GA-11 Approx. 47 g 	PL11 Approx. 15 g 	PL11-Q Approx. 18.5A 	PLE11-0 Approx. 10.8 g 
	PF113A-E * 	P2CF-11-E 		Note: The Y92A-48G Terminal Cover can be used to provide finger protection.			
14 pins	---	---	14PFA Approx. 104 g 	---	PL15 Approx. 28 g 	---	---
20 pins	---	---	---	---	PL20 Approx. 17 g 	---	---

Note: The structure of □-E models provides finger protection. Round terminals cannot be used. Use forked crimp terminals.
* Use a #1 Phillips screwdriver to tighten the screws on this Socket.

Minimum Order Lot

The following models are available at the minimum order lot specified below.

Number of pins	Model	PF	P2CF	PFA	P3G	PL
8 pins		PF083A, PF085A	P2CF-08, P2CF-08-E	8PFA, 8PFA1	P3G-08	PL08
11 pins		PF113A	P2CF-11, P2CF-11-E	11PFA	P3GA-11	PL11
14 pins		---	---	14PFA	---	PL15
Minimum order lot (pcs)		20	10	20	10	

Terminal Cover

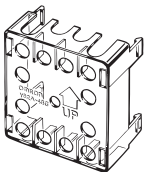
Model	Y92A-48G
Appearance	

Note: Refer to Models with Standards Certification for detailed information on the models of Common Sockets that are certified for standards.

Products Related to Common Sockets and DIN Tracks

Hold-down Clips For Square Sockets

(Unit: mm)

PHC-12 	PKC One Set (2 Clips) 	PTC-1 	PYC-A1 Approx. 0.54 g One Set (2 Clips) 	PYC-A2 One Set (2 Clips) 	PYC-E1 One Set (2 Clips)
PYC-P Approx. 1.4 g 	PYC-P2 Approx. 1.2 g 	PYC-S Approx. 1.8 g 	PYC-1 Approx. 6 g 	PYC-2 	PYC-3
PYC-5 	PYC Approx. 0.2 g 	Y92H-1 	Y92H-3 One Set (2 Clips) 	Y92H-4 	

For Round Sockets

PFC-A1 Approx. 2.2 g One Set (2 Clips) 	PFC-A6 Approx. 2.4 g One Set (2 Clips) 	PFC-A7 Approx. 3.0 g One Set (2 Clips) 	PLC Approx. 2.4 g One Set (2 Clips) 	PLC-1 Approx. 2.6 g One Set (2 Clips) 	PLC-7 Approx. 3.0 g One Set (2 Clips) 																				
PLC-8 Approx. 6.4 g One Set (2 Clips) 	PLC-10 Approx. 2.0 g One Set (2 Clips) 	PLC-12 Approx. 5.4 g One Set (2 Clips) 	Minimum Order Lot The following models are available at the minimum order lot specified below.																						
			<table border="1"> <thead> <tr> <th>Type</th> <th>Model</th> <th>Minimum order lot (pcs)</th> </tr> </thead> <tbody> <tr> <td rowspan="5">For Square Sockets</td> <td>PYC-A1</td> <td rowspan="5">100</td> </tr> <tr> <td>PYC-P</td> </tr> <tr> <td>PYC-A2</td> </tr> <tr> <td>PYC-S</td> </tr> <tr> <td>PYC-1</td> </tr> <tr> <td rowspan="5">For Round Sockets</td> <td>PYC-2</td> <td rowspan="5">10</td> </tr> <tr> <td>PYC-3</td> </tr> <tr> <td>PYC-5</td> </tr> <tr> <td>PFC-A1</td> <td rowspan="5">20</td> </tr> <tr> <td>PFC-A6</td> </tr> <tr> <td>PFC-A7</td> </tr> <tr> <td>PLC</td> </tr> </tbody> </table>	Type	Model	Minimum order lot (pcs)	For Square Sockets	PYC-A1	100	PYC-P	PYC-A2	PYC-S	PYC-1	For Round Sockets	PYC-2	10	PYC-3	PYC-5	PFC-A1	20	PFC-A6	PFC-A7	PLC		
Type	Model	Minimum order lot (pcs)																							
For Square Sockets	PYC-A1	100																							
	PYC-P																								
	PYC-A2																								
	PYC-S																								
	PYC-1																								
For Round Sockets	PYC-2	10																							
	PYC-3																								
	PYC-5																								
	PFC-A1		20																						
	PFC-A6																								
PFC-A7																									
PLC																									

Products Related to Common Sockets and DIN Tracks

Specifications

Socket Characteristics

Model	Continuous carry current	Dielectric strength	Insulation resistance*1	Remarks
P2RF-05(-E)(-S)	10 A	Between contact terminals of same polarity: 1,000 VAC for 1 min	1,000 MΩ min.	
		Between coil and contact terminals: 4,000 VAC for 1 min		
P2RF-08(-E)(-S)	5 A	Between contact terminals of different polarity: 3,000 VAC for 1 min	1,000 MΩ min.	
		Between contact terminals of same polarity: 1,000 VAC for 1 min		
		Between coil and contact terminals: 4,000 VAC for 1 min		
P2R-05P	10 A	Between contact terminals of same polarity: 1,000 VAC for 1 min	1,000 MΩ min.	
		Between coil and contact terminals: 4,000 VAC for 1 min		
P2R-08P	5 A	Between contact terminals of different polarity: 3,000 VAC for 1 min	1,000 MΩ min.	
		Between contact terminals of same polarity: 1,000 VAC for 1 min		
		Between coil and contact terminals: 4,000 VAC for 1 min		
P2R-057P	10 A	Between contact terminals of same polarity: 1,000 VAC for 1 min	1,000 MΩ min.	
		Between coil and contact terminals: 5,000 VAC for 1 min		
P2R-087P	5 A	Between contact terminals of different polarity: 3,000 VAC for 1 min	1,000 MΩ min.	
		Between contact terminals of same polarity: 1,000 VAC for 1 min		
		Between coil and contact terminals: 5,000 VAC for 1 min		
P2R-05A	10 A	Between contact terminals of same polarity: 1,000 VAC for 1 min	1,000 MΩ min.	
		Between ground terminals: 1,500 VAC for 1 min		
		Between coil and contact terminals: 4,000 VAC for 1 min		
P2R-08A	5 A	Between contact terminals of different polarity: 3,000 VAC for 1 min	1,000 MΩ min.	
		Between contact terminals of same polarity: 1,000 VAC for 1 min		
		Between ground terminals: 1,500 VAC for 1 min		
		Between coil and contact terminals: 4,000 VAC for 1 min		
P7TF-05	5 A	Between terminals: 2,000 VAC for 1 min	100 MΩ min.	
PYF08A(-E)(-S)	7 A, -S models: 10 A	Between terminals: 2,000 VAC for 1 min	1,000 MΩ min.	The continuous carry current of 10 A for the PYF08S is for an ambient temperature of 55°C. At an ambient temperature of 70°C, the value is 7 A.
PYF11A	5 A	Between terminals: 2,000 VAC for 1 min	1,000 MΩ min.	
PYF14A(-E)(-S)	3 A, -S models: 5 A	Between terminals: 2,000 VAC for 1 min	1,000 MΩ min.	
PY08(-Y1)	7 A	Between terminals: 1,500 VAC for 1 min	1,000 MΩ min.	
PY08QN(-Y1)	7 A	Between terminals: 1,500 VAC for 1 min	100 MΩ min.	
PY08-02	7 A	Between terminals: 1,500 VAC for 1 min	100 MΩ min.	
PY11(-Y1)	5 A	Between terminals: 1,500 VAC for 1 min	100 MΩ min.	
PY11QN(-Y1)	5 A	Between terminals: 1,500 VAC for 1 min	100 MΩ min.	
PY11-02	5 A	Between terminals: 1,500 VAC for 1 min	100 MΩ min.	
PY14(-Y1)	3 A	Between terminals: 1,500 VAC for 1 min	100 MΩ min.	
PY14QN(-Y1)	3 A	Between terminals: 1,500 VAC for 1 min	100 MΩ min.	
PY14-02	3 A	Between terminals: 1,500 VAC for 1 min	100 MΩ min.	
PTF□□A(-E)	10 A	Between terminals: 2,000 VAC for 1 min	100 MΩ min.	
PT□□	10 A	Between terminals: 2,000 VAC for 1 min	100 MΩ min.	
PT□□QN	10 A	Between terminals: 2,000 VAC for 1 min	100 MΩ min.	
PT□□-0	10 A	Between terminals: 2,000 VAC for 1 min	100 MΩ min.	
P7LF-06	30 A	Between contact terminals of different polarity: 2,000 VAC for 1 min	1,000 MΩ min.	
		Between contact terminals of same polarity: 2,000 VAC for 1 min		
		Between coil and contact terminals: 4,000 VAC for 1 min		
PF□□□A	5 A	Between terminals: 2,000 VAC for 1 min	1,000 MΩ min.	
P2CF	5 A	Between terminals: 2,000 VAC for 1 min	1,000 MΩ min.	
P3G(A)	6 A	Between terminals: 2,000 VAC for 1 min	1,000 MΩ min.	
8PFA(1)	10 A	Between terminals: 2,000 VAC for 1 min	1,000 MΩ min.	
11PFA(1)	10 A	Between terminals: 2,000 VAC for 1 min	1,000 MΩ min.	
PL□(-Q)	10 A	Between terminals: 2,000 VAC for 1 min	1,000 MΩ min.	
PLE□□-0	10 A	Between terminals: 2,000 VAC for 1 min	1,000 MΩ min.	
P6D-04P	5 A	Between contact terminals of same polarity: 1,000 VAC for 1 min	100 MΩ min.	
		Between coil and contact terminals: 3,000 VAC for 1 min		
P7S-14□-E(ND)	10 A	Between contact terminals of different polarity: 2,000 VAC for 1 min	1,000 MΩ min.	
		Between contact terminals of same polarity: 1,500 VAC for 1 min		
		Between coil and contact terminals: 2,000 VAC for 1 min		

Products Related to Common Sockets and DIN Tracks

Model	Continuous carry current	Dielectric strength	Insulation resistance*1	Remarks
P7SA-10□	6 A *2	Between contact terminals of different polarity: 2,500 VAC for 1 min	1,000 MΩ min.	
		Between contact terminals of same polarity: 1,500 VAC for 1 min		
		Between coil and contact terminals: 2,500 VAC for 1 min		
P7SA-14□	6 A *2	Between contact terminals of different polarity: 2,500 VAC for 1 min	1,000 MΩ min.	
		Between contact terminals of same polarity: 1,500 VAC for 1 min		
		Between coil and contact terminals: 2,500 VAC for 1 min		

*1. The insulation resistance was measured with a 500-VDC insulation resistance meter at the same places as those used for measuring the dielectric strength.

*2. There are restrictions in the current. Refer to the *General Catalog for the OMRON Safety Components* (Cat. No. Y106) for details.

Safety Precautions

Refer to *Common Relay Precautions* for general precautions.

Products Related to Common Sockets and DIN Tracks

Dimensions

P2RF

(Unit: mm)

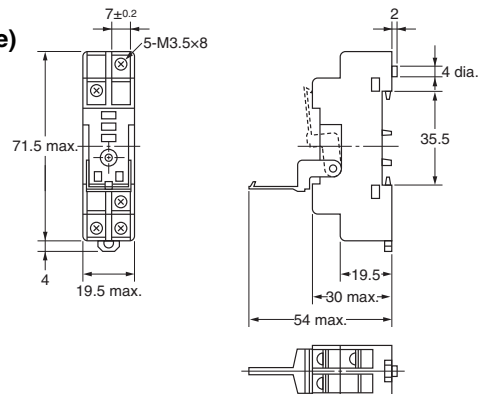
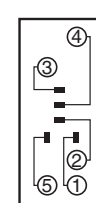
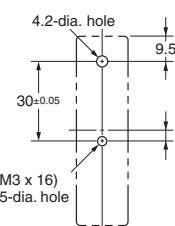
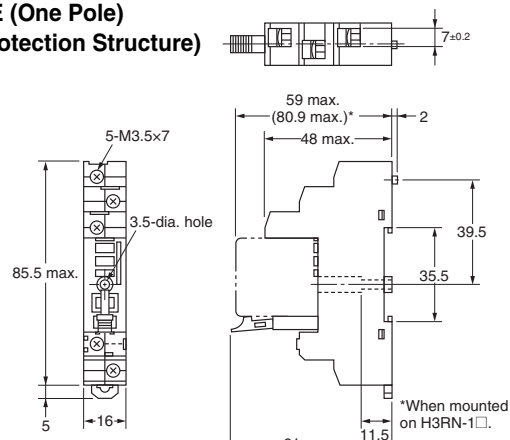
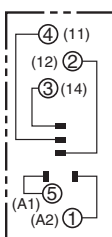
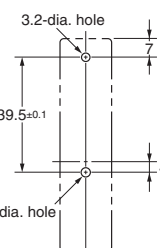
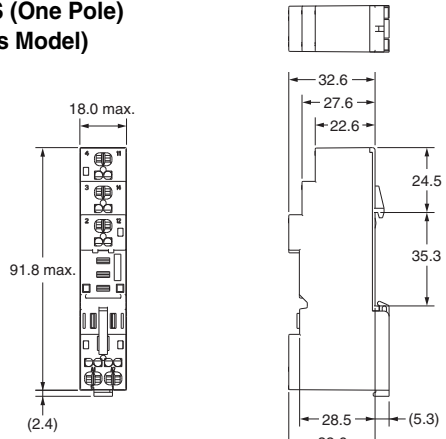
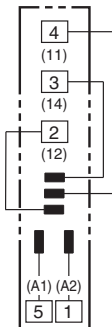
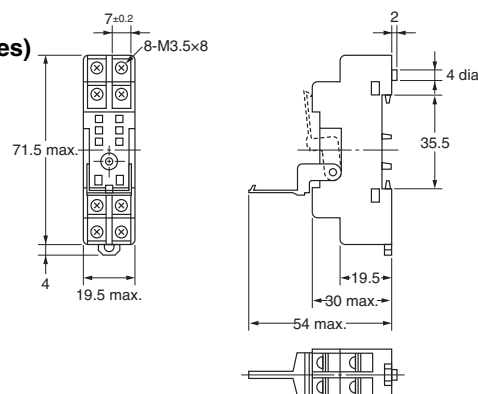
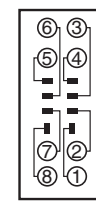
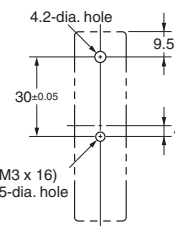
Dimensions	Terminal Arrangement/ Internal Connections	Mounting Hole Dimensions
<p>P2RF-05 (One Pole)</p> 	 <p>(Top View)</p>	 <p>(Top View)</p> <p>Note: Track mounting is also possible. Refer to page 28.</p>
<p>P2RF-05-E (One Pole) (Finger Protection Structure)</p> 	 <p>(Top View)</p> <p>Note: Figures in parentheses indicate DIN standard numbers.</p>	 <p>(Top View)</p> <p>Note: Track mounting is also possible. Refer to page 28.</p>
<p>P2RF-05-S (One Pole) (Screwless Model)</p> 	 <p>(Top View)</p> <p>Note: Figures in parentheses indicate DIN standard numbers.</p>	<p>---</p>
<p>P2RF-08 (Two Poles)</p> 	 <p>(Top View)</p>	 <p>(Top View)</p> <p>Note: Track mounting is also possible. Refer to page 28.</p>

Products Related to Common Sockets and DIN Tracks

P2RF

(Unit: mm)

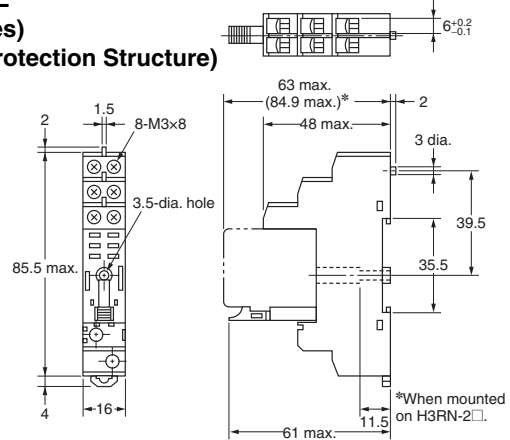
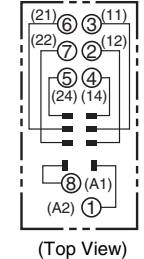
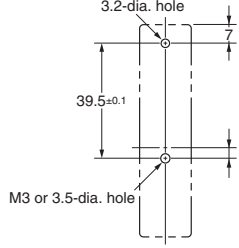
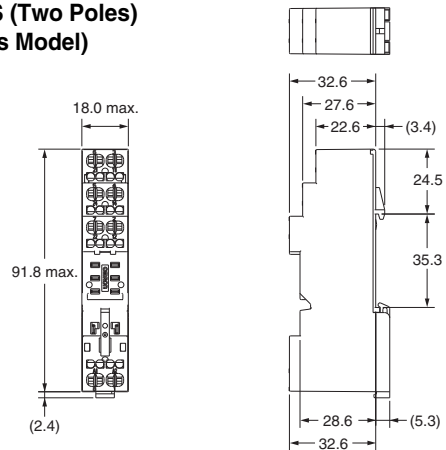
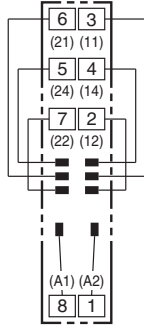



Dimensions	Terminal Arrangement/ Internal Connections	Mounting Hole Dimensions
<p>P2RF-08-E (Two Poles) (Finger Protection Structure)</p> 	 <p>(Top View)</p> <p>Note: Figures in parentheses indicate DIN standard numbers.</p>	 <p>(Top View)</p> <p>Note: Track mounting is also possible. Refer to page 28.</p>
<p>P2RF-08-S (Two Poles) (Screwless Model)</p> 	 <p>(Top View)</p> <p>Note: Figures in parentheses indicate DIN standard numbers.</p>	<p>---</p>

- Note:**
1. If an I/O SSR or Indicator Module is used, the polarity of terminal 1 is negative.
 2. Refer to pages 29 and 30 for the features of Screwless Sockets and for precautions for correct use.

Products Related to Common Sockets and DIN Tracks

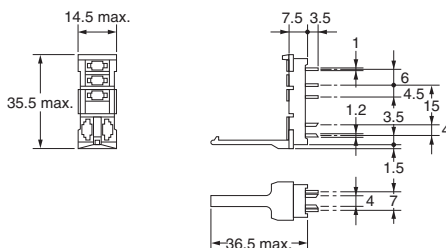
P2R

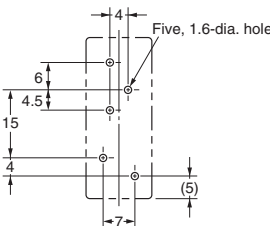
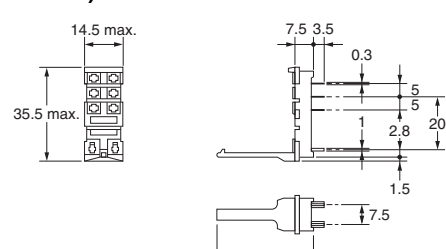
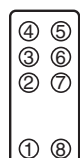
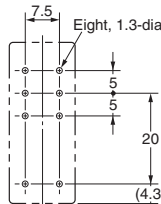
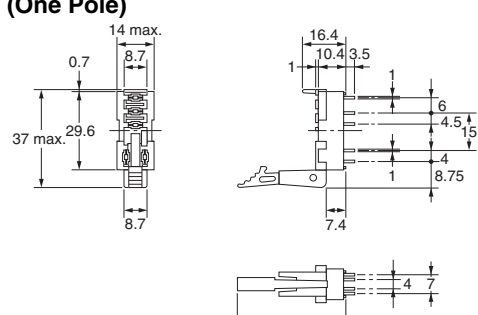
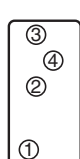
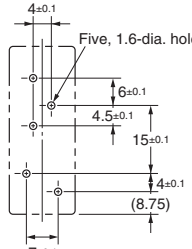
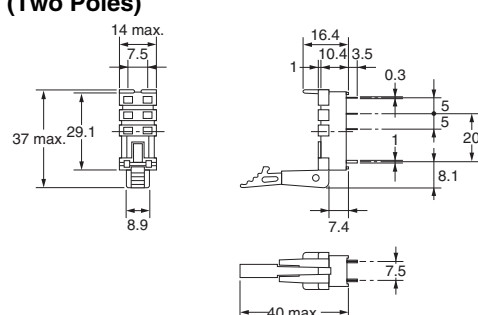
(Unit: mm)

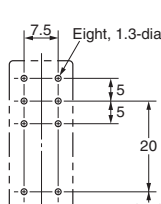
Dimensions	Terminal Arrangement/ Internal Connections	PCB Dimensions
<p>P2R-05P (One Pole)</p> 	 <p>(Bottom View)</p>	 <p>(Bottom View)</p>
<p>P2R-08P (Two Poles)</p> 	 <p>(Bottom View)</p>	 <p>(Bottom View)</p>
<p>P2R-057P (One Pole)</p> 	 <p>(Bottom View)</p>	 <p>(Bottom View)</p>
<p>P2R-087P (Two Poles)</p> 	 <p>(Bottom View)</p>	 <p>(Bottom View)</p>

Note: If an I/O SSR or Indicator Module is used, the polarity of terminal 1 is negative.

Products Related to Common Sockets and DIN Tracks

P2R

(Unit: mm)

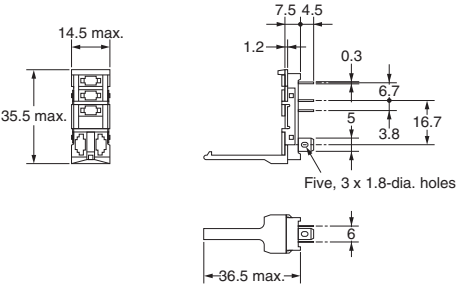
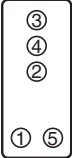
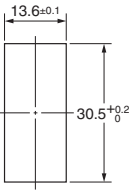
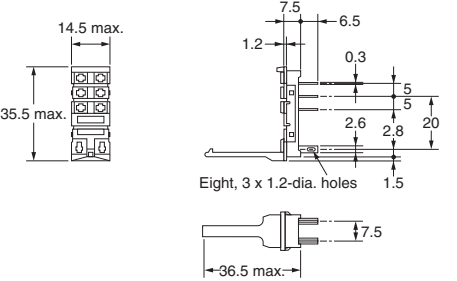
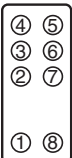
Dimensions	Terminal Arrangement/ Internal Connections	Mounting Hole Dimensions
<p>P2R-05A (One Pole)</p> 	 <p>(Bottom View)</p>	 <p>(Use panel with thickness of 1.6 to 2.0 mm.)</p>
<p>P2R-08A (Two Poles)</p> 	 <p>(Bottom View)</p>	<p>(Use panel with thickness of 1.6 to 2.0 mm.)</p>

Note: If an I/O SSR or Indicator Module is used, the polarity of terminal 1 is negative.

P7TF

(Unit: mm)

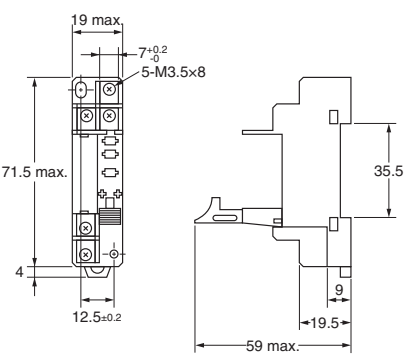
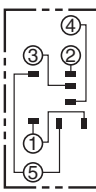
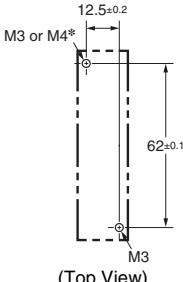
Dimensions	Terminal Arrangement/ Internal Connections	Mounting Hole Dimensions
<p>P7TF-05</p> 	 <p>(Top View)</p>	 <p>(Top View)</p> <p>Note: Track mounting is also possible. Refer to page 28. * We recommend that you use washers if you use M3 bolts or screws. Washers are not required with M4 bolts or screws.</p>

Note: If an I/O SSR or Indicator Module is used, the polarity of terminal 1 is positive.

Products Related to Common Sockets and DIN Tracks

PYF

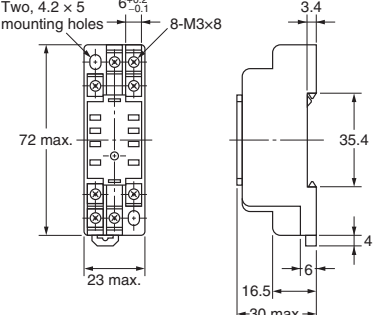
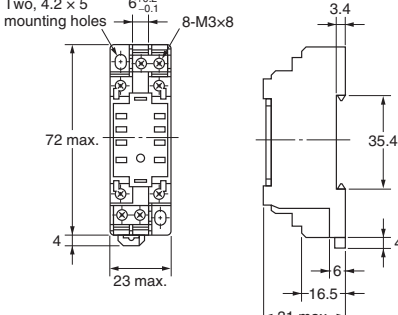
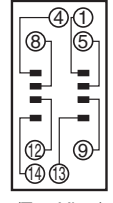
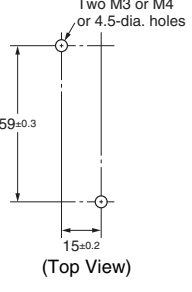
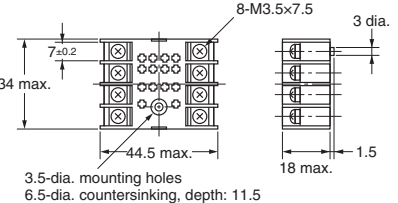
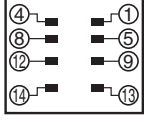
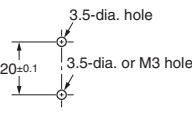
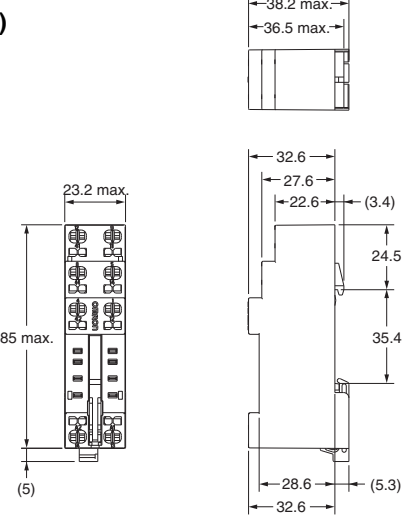
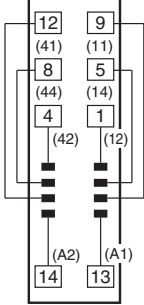
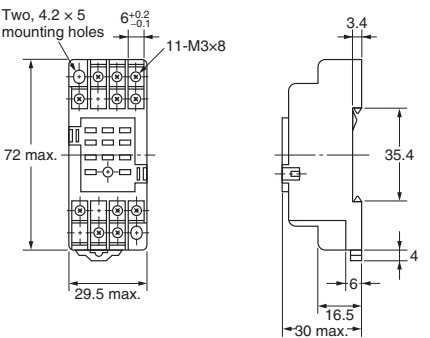
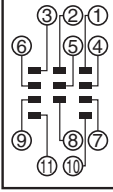
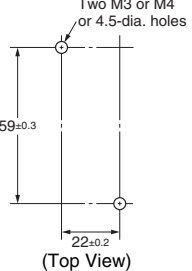

(Unit: mm)

Dimensions	Terminal Arrangement/Internal Connections	Mounting Hole Dimensions
<p>PYF08A</p>  <p>PYF08A-E (Finger Protection Structure)</p> 	 <p>(Top View)</p>	 <p>Two M3 or M4 or 4.5-dia. holes</p> <p>59±0.3</p> <p>15±0.2</p> <p>(Top View)</p> <p>Note: Track mounting is also possible. Refer to page 28.</p>
<p>PYF08M</p>  <p>8-M3.5x7.5</p> <p>3 dia.</p> <p>7±0.2</p> <p>34 max.</p> <p>44.5 max.</p> <p>3.5-dia. mounting holes</p> <p>6.5-dia. countersinking, depth: 11.5</p> <p>18 max.</p> <p>1.5</p>	 <p>(Top View)</p>	 <p>3.5-dia. hole</p> <p>20±0.1</p> <p>3.5-dia. or M3 hole</p>
<p>PYF08S (Screwless Model)</p>  <p>38.2 max.</p> <p>36.5 max.</p> <p>23.2 max.</p> <p>85 max.</p> <p>32.6</p> <p>27.6</p> <p>22.6 (3.4)</p> <p>24.5</p> <p>35.4</p> <p>28.6 (5.3)</p> <p>32.6</p>	 <p>(Top View)</p> <p>Note: Figures in parentheses indicate DIN standard numbers.</p>	<p>---</p>
<p>PYF11A</p>  <p>Two, 4.2 x 5 mounting holes</p> <p>6±0.2 / -0.1</p> <p>11-M3x8</p> <p>72 max.</p> <p>29.5 max.</p> <p>3.4</p> <p>35.4</p> <p>4</p> <p>16.5</p> <p>30 max.</p>	 <p>(Top View)</p>	 <p>Two M3 or M4 or 4.5-dia. holes</p> <p>59±0.3</p> <p>22±0.2</p> <p>(Top View)</p> <p>Note: Track mounting is also possible. Refer to page 28.</p>

Products Related to Common Sockets and DIN Tracks

PYF

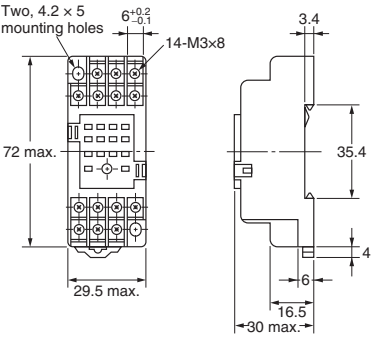
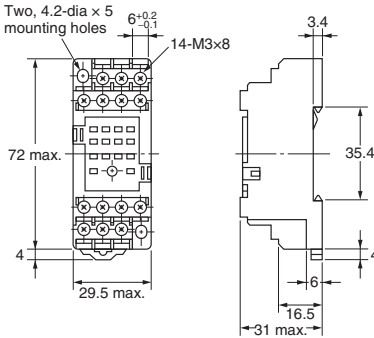
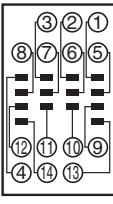
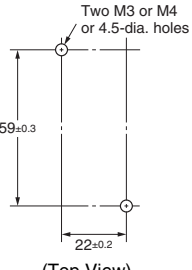
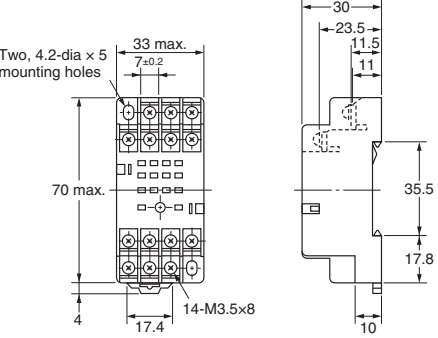
(Unit: mm)

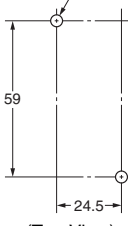
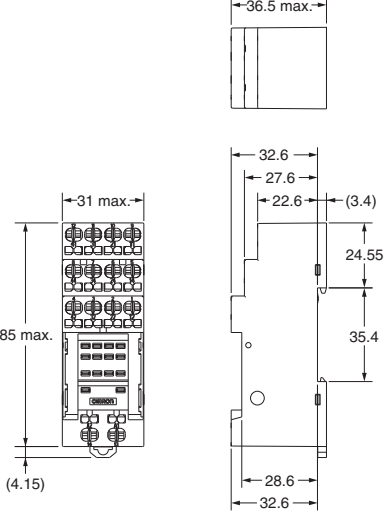
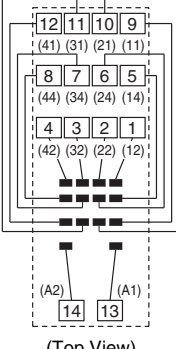

Dimensions	Terminal Arrangement/Internal Connections	Mounting Hole Dimensions
<p>PYF14A</p>  <p>PYF14A-E (Finger Protection Structure)</p> 	 <p>(Top View)</p>	 <p>(Top View)</p> <p>Note: Track mounting is also possible. Refer to page 28.</p>
<p>PYF14T</p> 	 <p>(Top View)</p>	 <p>(Top View)</p> <p>Note: Track mounting is also possible. Refer to page 28.</p>
<p>PYF14S (Screwless Model)</p> 	 <p>(Top View)</p> <p>Note: Figures in parentheses indicate DIN standard numbers.</p>	<p>---</p>

Note: Refer to pages 29 and 30 for the features of Screwless Sockets and for precautions for correct use.

Products Related to Common Sockets and DIN Tracks

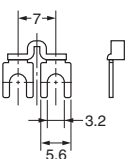

Relay Sockets and Socket Bridges for PYF

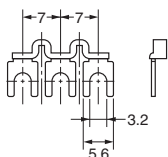
Bridges within the Same Socket

Pitch	Applicable models	Appearance	Dimensions (mm)	Model	Specifications
7 mm	PYF14A			PYD-020B□(2P)	Max. carry current: 20 A (18 A at 70°C) Ambient operating temperature: -40 to 70°C (with no icing or condensation) Ambient operating humidity: 45% to 85% (with no icing or condensation) Conductor material: Brass Conductor surface treatment: Nickel plating Package qty: 50/bag
				PYD-030B□(3P)	

Note: 1. The □ in the model number is replaced with the insulation color specification code. B: Black, Y: Yellow
 2. Specify the number of bags when ordering.

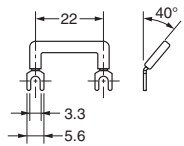
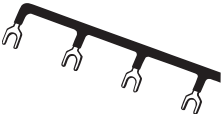
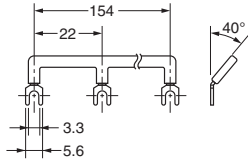
Bridges between Adjacent Sockets

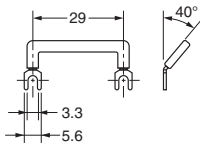
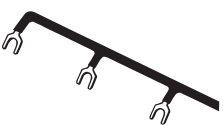
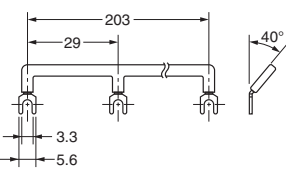
Pitch	Applicable models	Appearance	Dimensions (mm)	Model	Specifications
22 mm	PYF08A			PYD-025B□(2P)	Max. carry current: 20 A (18 A at 70°C) Ambient operating temperature: -40 to 70°C (with no icing or condensation) Ambient operating humidity: 45% to 85% (with no icing or condensation) Conductor material: Brass Conductor surface treatment: Nickel plating Package qty: 10/bag
				PYD-085B□(8P)	
29 mm	PYF14A			PYD-026B□(2P)	Max. carry current: 20 A (18 A at 70°C) Ambient operating temperature: -40 to 70°C (with no icing or condensation) Ambient operating humidity: 45% to 85% (with no icing or condensation) Conductor material: Brass Conductor surface treatment: Nickel plating Package qty: 10/bag
				PYD-086B□(8P)	

Note: 1. The □ in the model number is replaced with the insulation color specification code. B: Black, S: Blue, R: Red
 2. Specify the number of bags when ordering.

Socket Bridges

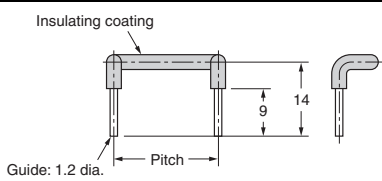
Pitch	Applicable models	Appearance and dimensions (mm)	Model	Insulation color
19.7 mm	PYF08S		PYDM-08SR	Red
			PYDM-08SB	Blue
27.5 mm	PYF14S		PYDM-14SR	Red
			PYDM-14SB	Blue
14.3 mm	P2RF-□□-S		P2RM-SR	Red
		P2RM-SB	Blue	

Note: 1. Use the Socket Bridges for relay coil bridge wiring.
 2. Specify the number of bags when ordering.

Safety Precautions

Maximum Carry Current

- The total current of all bridged poles must not exceed the maximum carry current of the Socket Bridge.
- Make sure that the maximum carry current of the relay contacts is also not exceeded for each pole.
- If you use more than one Socket, use End Plates (PFP-M).

Products Related to Common Sockets and DIN Tracks

PY

(Unit: mm)

Dimensions	Terminal Arrangement/ Internal Connections	Mounting hole and PCB dimensions
<p>PY08 PY08-Y1 (L = 42 max.) PY08-Y13 (L = 60 max.)</p> <p>*The PY08-Y□ includes the part outlined by the dashed lines above.</p>		
<p>PY08QN PY08QN2 PY08QN-Y1 PY08QN2-Y1</p> <p>*1. The PY08QN(2)-Y1 includes the part outlined by the dashed lines above. *2. The figures in the parentheses are for the PY08QN2(-Y1).</p>	<p>(Bottom View)</p>	
<p>PY08-02</p> <p>* The structure does not resist flux. Manual soldering is recommended for this product.</p>		
<p>PY11 PY11-Y1</p> <p>*The PY11-Y1 includes the part outlined by the dashed lines above.</p>		
<p>PY11QN PY11QN2 PY11QN-Y1 PY11QN2-Y1</p> <p>*1. The PY11QN(2)-Y1 includes the part outlined by the dashed lines above. *2. The figures in the parentheses are for the PY11QN2(-Y1).</p>	<p>(Bottom View)</p>	
<p>PY11-02</p> <p>* The structure does not resist flux. Manual soldering is recommended for this product.</p>		

Products Related to Common Sockets and DIN Tracks

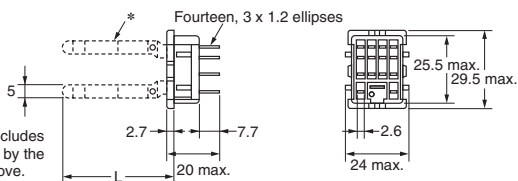
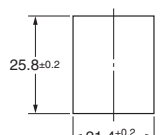
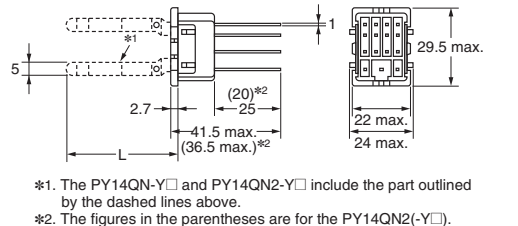
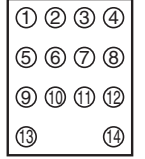
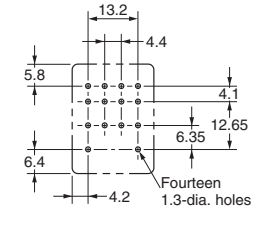
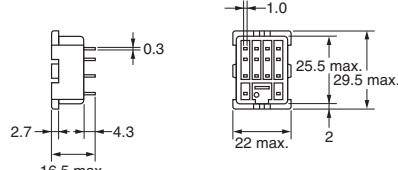
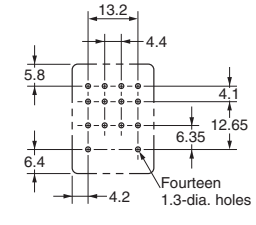
Dimensions	Terminal Arrangement/ Internal Connections	Mounting hole and PCB dimensions
<p>PY14 PY14-Y1 (L = 42 max.) PY14-Y3 (L = 60 max.)</p>  <p>*The PY14-Y□ includes the part outlined by the dashed lines above.</p>		
<p>PY14QN PY14QN2 PY14QN-Y1 (L = 42 max.) PY14QN2-Y1 (L = 42 max.) PY14QN-Y3 (L = 60 max.) PY14QN2-Y3 (L = 60 max.)</p>  <p>*1. The PY14QN-Y□ and PY14QN2-Y□ include the part outlined by the dashed lines above. *2. The figures in the parentheses are for the PY14QN2(-Y□).</p>	 <p>(Bottom View)</p>	
<p>PY14-02</p> <p>* The structure does not resist flux. Manual soldering is recommended for this product.</p> 		

- Note:**
1. Use a panel with a thickness of 1 to 2 mm when mounting a Socket on it.
 2. You can use the PY14-Y1 or PY14QN-Y1 for the MY4 Series, MY4H, MYQ4(Z), or MY2K.
 3. You can use the PY14-Y3 or PY14QN-Y3 for H3Y Timers.

PTF

(Unit: mm)

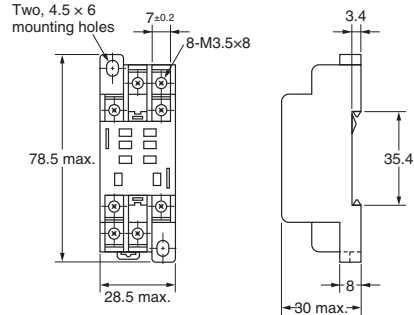
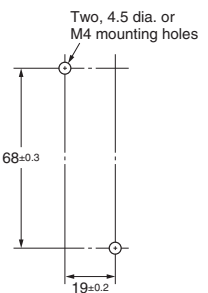
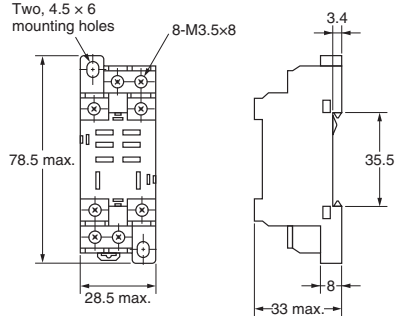
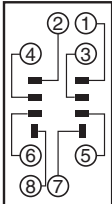
Dimensions	Terminal Arrangement/ Internal Connections	Mounting Hole Dimensions
<p>PTF08A</p> 		
<p>PTF08A-E (Finger Protection Structure)</p> 	 <p>(Top View)</p>	<p>Note: Track mounting is also possible. Refer to page 28.</p>

Products Related to Common Sockets and DIN Tracks

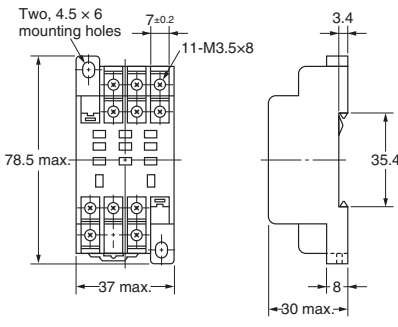
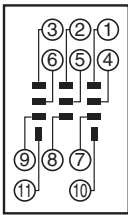
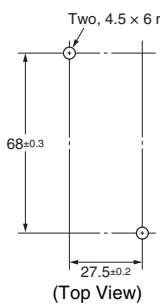
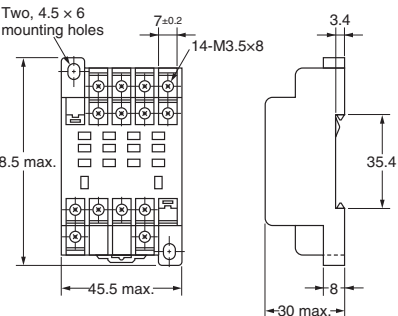
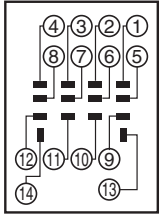
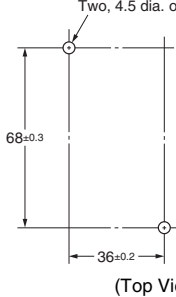
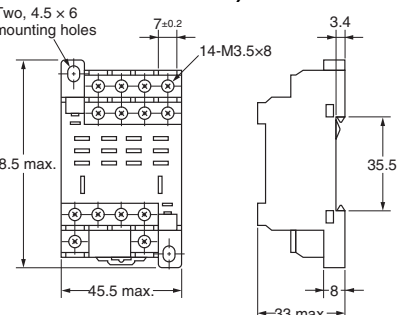
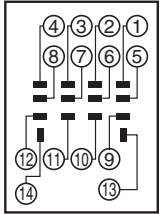
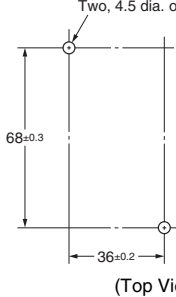
Dimensions	Terminal Arrangement/ Internal Connections	Mounting Hole Dimensions
<p>PTF11A</p> 	 <p>(Top View)</p>	 <p>(Top View)</p> <p>Note: Track mounting is also possible. Refer to page 28.</p>
<p>PTF14A</p> 	 <p>(Top View)</p>	 <p>(Top View)</p> <p>Note: Track mounting is also possible. Refer to page 28.</p>
<p>PTF14A-E (Finger Protection Structure)</p> 	 <p>(Top View)</p>	 <p>(Top View)</p> <p>Note: Track mounting is also possible. Refer to page 28.</p>

Note: If you use the PTF08A, PTF08A-E, or PT08 with an LY1 Relay, connect the following terminal pairs: 1-2, 3-4, and 5-6 (for usage at 10 A or higher).

PT (Unit: mm)

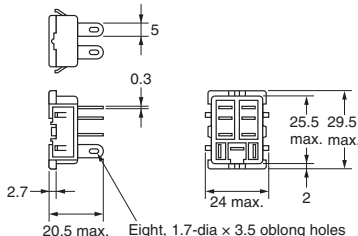
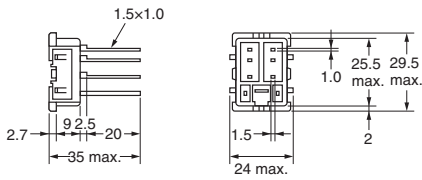
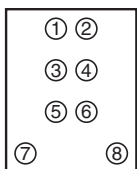
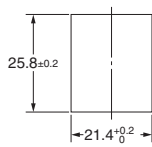
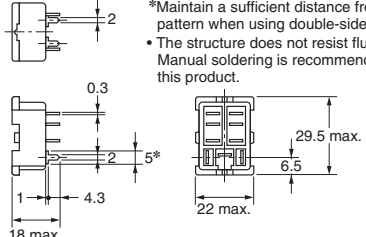
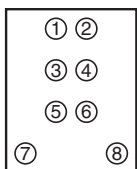
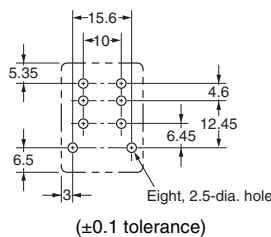
Dimensions	Terminal Arrangement/ Internal Connections	Mounting hole and PCB dimensions
<p>PT08</p>  <p>Eight, 1.7-dia × 3.5 oblong holes</p> <p>PT08QN</p> 	 <p>(Top View)</p>	
<p>PT08-0</p>  <p>*Maintain a sufficient distance from the pattern when using double-sided PCBs. • The structure does not resist flux. Manual soldering is recommended for this product.</p>	 <p>(Bottom View)</p>	 <p>(±0.1 tolerance)</p>

Products Related to Common Sockets and DIN Tracks

Dimensions		Terminal Arrangement/ Internal Connections	Mounting hole and PCB dimensions
PT11 	PT11QN 	<p>(Bottom View)</p>	
PT11-0 <p>*Maintain a sufficient distance from the pattern when using double-sided PCBs. • The structure does not resist flux. Manual soldering is recommended for this product.</p>	<p>(±0.1 tolerance)</p>		
PT14 	PT14QN 	<p>(Bottom View)</p>	
PT14-0 <p>*Maintain a sufficient distance from the pattern when using double-sided PCBs. • The structure does not resist flux. Manual soldering is recommended for this product.</p>	<p>(±0.1 tolerance)</p>		

Note: Use a panel with a thickness of 1 to 2 mm when mounting a Socket on it.

Products Related to Common Sockets and DIN Tracks

P7LF

(Unit: mm)

Dimensions	Terminal Arrangement/ Internal Connections	Mounting Hole Dimensions
<p>P7LF-06</p> <p>Two, M3.5 x 6 (coil side)</p> <p>Four, M4 x 8 (contact side)</p> <p>40±0.1</p> <p>55.5 max.</p> <p>8±0.05</p> <p>9.2±0.05</p> <p>51.5 max.</p> <p>25</p> <p>46 max.</p> <p>5</p>	<p>(Top View)</p>	<p>Two, 4.5 dia. or M4 mounting holes</p> <p>40±0.1</p>

P7S

(Unit: mm)

Dimensions	Terminal Arrangement/ Internal Connections	Mounting Hole Dimensions
<p>P7S-14F-END</p> <p>Indicator LED</p> <p>14-M3.0x8</p> <p>40 max.</p> <p>33±0.1</p> <p>7.5</p> <p>4</p> <p>4</p> <p>80 max.</p> <p>37</p> <p>17</p> <p>5</p> <p>90.5 max.</p> <p>3.1</p> <p>5.9</p> <p>(5)</p>		<p>Two, 4.0 dia. or M3.5</p> <p>33±0.1</p>
<p>P7S-14P-E</p> <p>70.5 max.</p> <p>28±0.2</p> <p>23.5 max.</p> <p>Two, 6.5 dia., depth: 8</p> <p>57 max.</p> <p>13.2</p> <p>4.1</p> <p>23.5 max.</p> <p>14.5</p> <p>8</p> <p>6</p> <p>7</p> <p>5x7=35</p> <p>16.9</p> <p>(15)</p>	<p>G7S-4A2B-E Mounted</p> <p>G7S-3A3B-E Mounted</p>	<p>28±0.2</p> <p>4.2</p> <p>(21)</p> <p>2.8</p> <p>14.5</p> <p>8</p> <p>16</p> <p>7</p> <p>Two, 6.5 dia.</p> <p>5x7=35</p> <p>16.9</p>

Products Related to Common Sockets and DIN Tracks

P7SA

(Unit: mm)

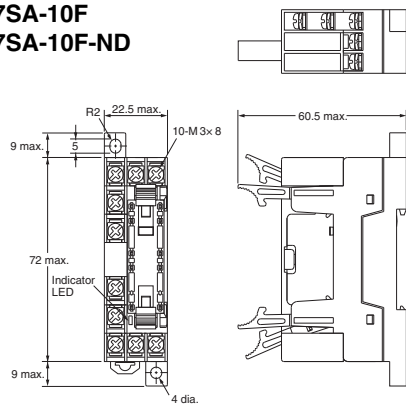
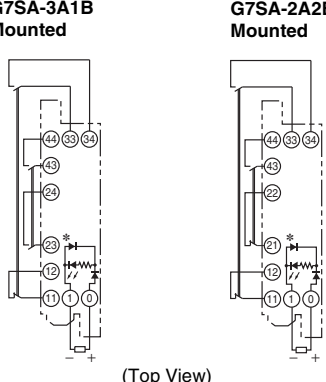
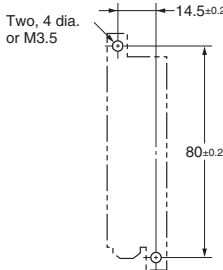
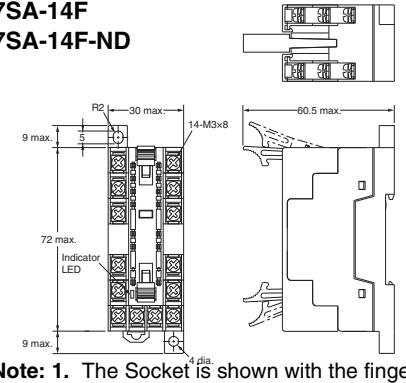
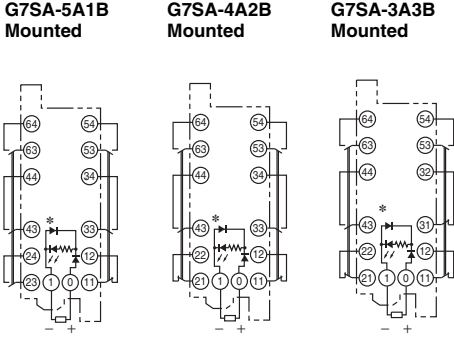
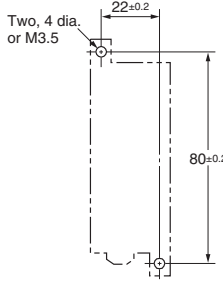
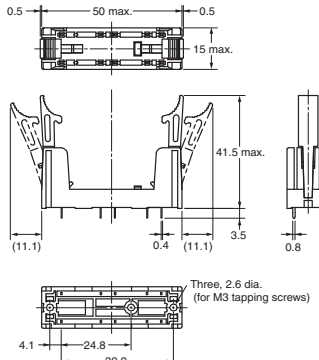
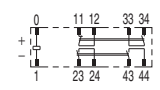
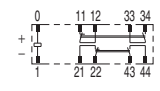
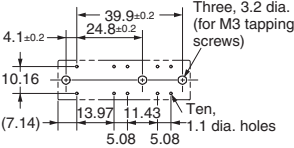
Dimensions	Terminal Arrangement/Internal Connections	Mounting Hole Dimensions
<p>P7SA-10F P7SA-10F-ND</p>  <p>Note: 1. The Socket is shown with the finger cover removed. 2. Only the -ND Sockets have LED indicators (orange).</p>	<p>G7SA-3A1B Mounted G7SA-2A2B Mounted</p>  <p>(Top View)</p> <p>* This display circuit is provided only on -ND models. Note: Terminals 23-24, 33-34, and 43-44 are normally open. Terminals 11-12 and 21-22 are normally closed.</p>	 <p>(Top View)</p>
<p>P7SA-14F P7SA-14F-ND</p>  <p>Note: 1. The Socket is shown with the finger cover removed. 2. Only the -ND Sockets have LED indicators (orange).</p>	<p>G7SA-5A1B Mounted G7SA-4A2B Mounted G7SA-3A3B Mounted</p>  <p>(Top View)</p> <p>* This display circuit is provided only on -ND models. Note: Terminals 23-24, 33-34, 43-44, 53-54, and 63-64 are normally open. Terminals 11-12, 21-22, and 31-32 are normally closed.</p>	 <p>(Top View)</p>
<p>P7SA-10P</p>  <p>Three, 2.6 dia. (for M3 tapping screws)</p>	<p>G7SA-3A1B Mounted</p>  <p>G7SA-2A2B Mounted</p>  <p>(Bottom View)</p> <p>Note: Terminals 23-24, 33-34, and 43-44 are normally open. Terminals 11-12 and 21-22 are normally closed.</p>	 <p>(Bottom View)</p> <p>(±0.1 tolerance)</p>

Products Related to Common Sockets and DIN Tracks

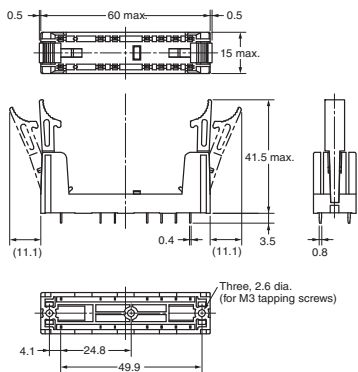
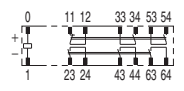
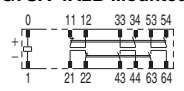
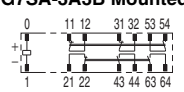
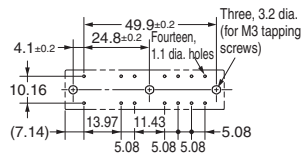
Dimensions	Terminal Arrangement/Internal Connections	Mounting Hole Dimensions
<p>P7SA-14P</p> 	<p>G7SA-5A1B Mounted</p>  <p>G7SA-4A2B Mounted</p>  <p>G7SA-3A3B Mounted</p>  <p>(Bottom View)</p> <p>Note: Terminals 23-24, 33-34, 43-44, 53-54, and 63-64 are normally open. Terminals 11-12, 21-22, and 31-32 are normally closed.</p>	 <p>(Bottom View)</p> <p>(±0.1 tolerance)</p>

Products Related to Common Sockets and DIN Tracks

PF

(Unit: mm)

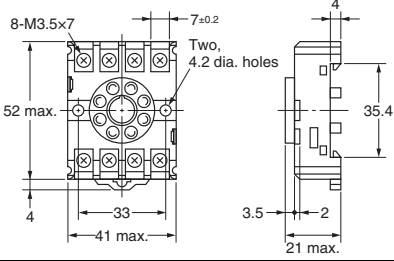
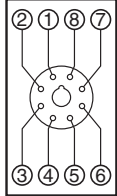
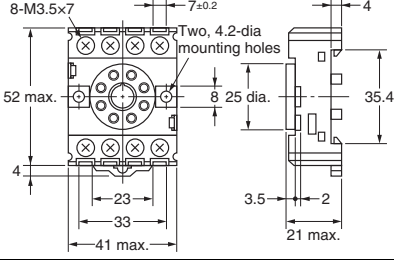
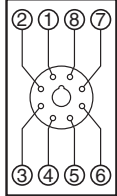
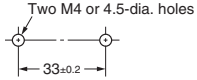
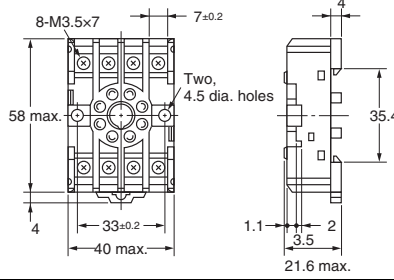
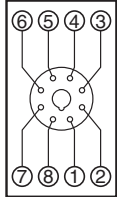
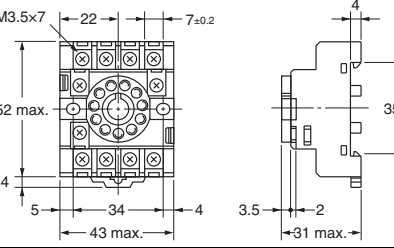
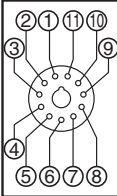
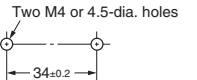
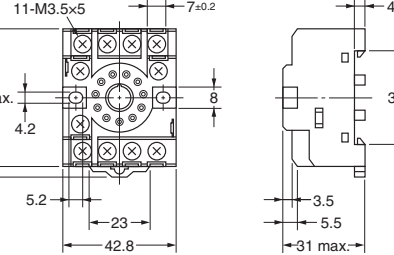
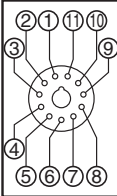
Dimensions	Terminal Arrangement/ Internal Connections	Mounting Hole Dimensions
<p>PF083A</p> 	 <p>(Top View)</p>	
<p>PF083A-E</p> 	 <p>(Top View)</p>	 <p>Note: Track mounting is also possible. Refer to page 28.</p>
<p>PF085A</p> 	 <p>(Top View)</p>	
<p>PF113A</p> 	 <p>(Top View)</p>	 <p>Note: Track mounting is also possible. Refer to page 28.</p>
<p>PF113A-E</p> 	 <p>(Top View)</p>	<p>Note: Track mounting is also possible. Refer to page 28.</p>

Note: 1. For the PF083A and PF113A, the Socket key slot is on the top. (Applicable model: MK)

2. The structure of □-E models provides finger protection. Round terminals cannot be used. Use forked crimp terminals.

Products Related to Common Sockets and DIN Tracks

P2CF

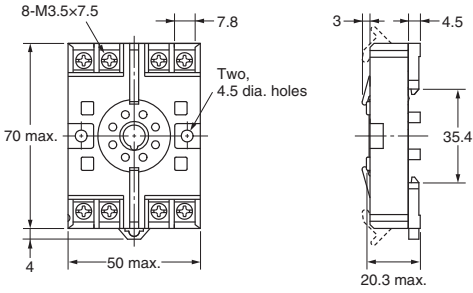
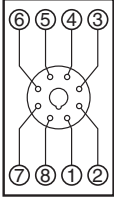
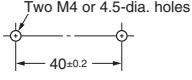
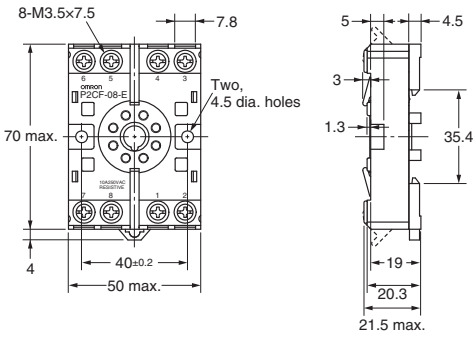
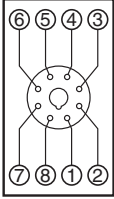
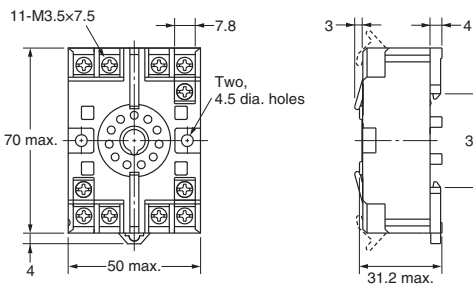
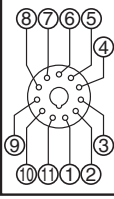
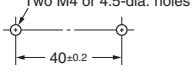
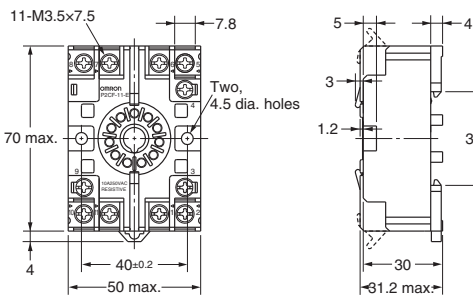
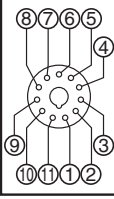

(Unit: mm)

Dimensions	Terminal Arrangement/ Internal Connections	Mounting Hole Dimensions
<p>P2CF-08</p> 	 <p>(Top View)</p>	 <p>Two M4 or 4.5-dia. holes 40±0.2</p>
<p>P2CF-08-E</p> 	 <p>(Top View)</p>	<p>Note: Track mounting is also possible. Refer to page 28.</p>
<p>P2CF-11</p> 	 <p>(Top View)</p>	 <p>Two M4 or 4.5-dia. holes 40±0.2</p>
<p>P2CF-11-E</p> 	 <p>(Top View)</p>	<p>Note: Track mounting is also possible. Refer to page 28.</p>

Products Related to Common Sockets and DIN Tracks

PFA

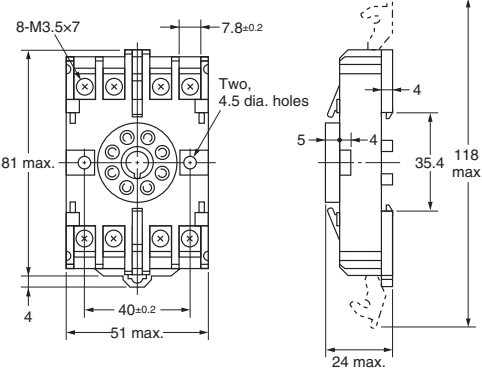
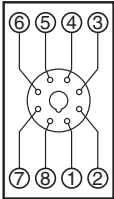
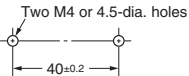
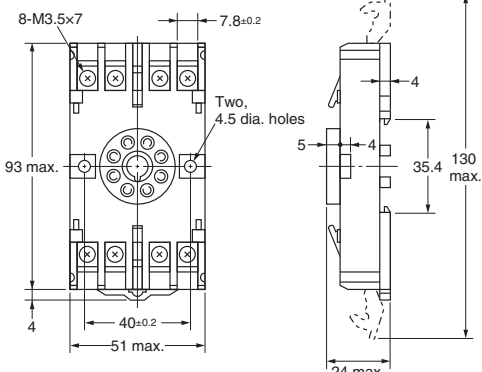
(Unit: mm)

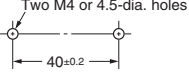
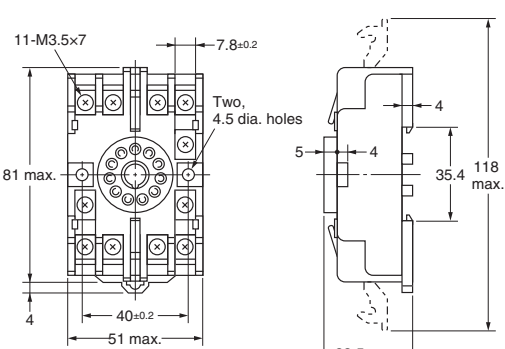
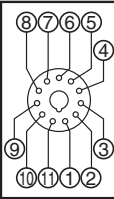
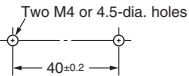
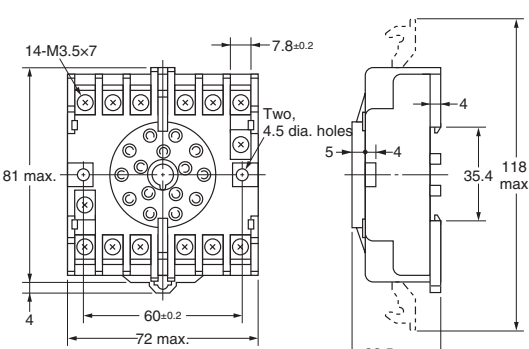
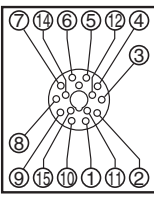
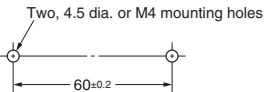
Dimensions	Terminal Arrangement/ Internal Connections	Mounting Hole Dimensions
<p>8PFA</p> 	 <p>(Top View)</p>	 <p>Note: Track mounting is also possible. Refer to page 28.</p>
<p>8PFA1</p> 	 <p>(Top View)</p>	 <p>Note: Track mounting is also possible. Refer to page 28.</p>
<p>11PFA</p> 	 <p>(Top View)</p>	 <p>Note: Track mounting is also possible. Refer to page 28.</p>
<p>14PFA</p> 	 <p>(Top View)</p>	 <p>Note: Track mounting is also possible. Refer to page 28.</p>

Products Related to Common Sockets and DIN Tracks

P3G/P3GA

(Unit: mm)

Dimensions	Terminal Arrangement/ Internal Connections	Mounting Hole Dimensions
<p>P3G-08</p> <p>→27 dia.→ 45 45 4.9 → 17 → Eight, M3.5 SEMS screws</p> <p>Note: The Y92A-48G Terminal Cover can be used to implement finger protection.</p>	<p>(Bottom View)</p>	---
<p>P3GA-11</p> <p>→27 dia.→ 45 45 25.6 4.5 → 16.3 → 6.2 Eleven, M3.5 SEMS screws</p> <p>Note: The Y92A-48G Terminal Cover can be used to implement finger protection.</p>	<p>(Bottom View)</p>	---

Terminal Cover

(Unit: mm)

Appearance	Dimensions
	<p>Y92A-48G</p> <p>Twelve, 6.4 dia.</p> <p>34 47.7 × 47.7 48 × 48 16.5 24.6 27.6 47.4</p>

Release Lever

(Unit: mm)

Applicable models	Appearance	Dimensions	Model
PYF08S		<p>16 32.7 54.4</p>	PYCM-08S
PYF14S		<p>28 29.6 52.5</p>	PYCM-14S
P2RF-05-S		<p>16.8 40.35</p>	P2CM-S
P2RF-08-S		<p>36</p>	

Products Related to Common Sockets and DIN Tracks

PL		(Unit: mm)	
Dimensions	Terminal Arrangement/ Internal Connections	Mounting hole and PCB dimensions (bottom view)	
PL08 		Two, 3.5 dia. or M3 device mounting holes Two, 3.5 or M3 Socket mounting holes L = 40 mm MK2(Z)P L = 74 mm PU, AMD-S, MM2(X)P, CZ, STP, H3L, TDS, DTS, DSP, TDF, TDV L = 86 mm 61F-GP/-APN, G4Q-212S, RD2P, RDA, TDA, AGF, SE, SAD, K2CU, SDV-F 	
PL08-Q 	 (Bottom View)	Two 3.5-dia. or two M3 Socket mounting holes L = 40 mm MK2(Z)P 	
PLE08-0 		Two 3.5-dia. Hold-down Clip mounting holes L = 40 mm MK2(Z)P 	
PL11 		Two, 3.5 dia. or M3 device mounting /Hold-down Clip mounting holes Two, 3.5 dia. or M3 Socket mounting holes L = 40 mm MK3P MK2KP L = 74 mm MM3P MK2(X)KP 	
PL11-Q 	 (Bottom View)	L = 42 mm MK3ZP MK3LP 	
PLE11-0 		Two, 3.5-dia. holes Applicable model/Hold-down Clip mounting holes L = 40 mm MK3P MK2KP L = 42 mm MK3ZP MK3LP 	
PL15 	 (Bottom View)	Two, 3.5 dia. or M3 device mounting holes Two, 3.5 dia. or M3 Socket mounting holes L = 74 mm MM3XP MM4(X)P MM3(X)KP MM4(X)KP 	

Products Related to Common Sockets and DIN Tracks

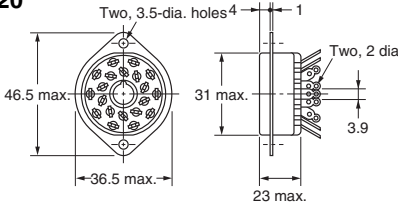
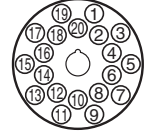
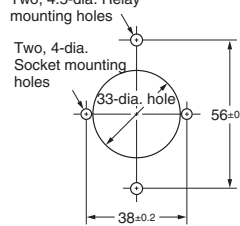
Dimensions	Terminal Arrangement/ Internal Connections	Mounting hole and PCB dimensions (bottom view)
<p>PL20</p> 	 <p>(Bottom View)</p>	 <p>* Relay mounting holes are not required for the LDNP.</p>

Note: When mounting, pay due attention to the direction of the key groove of applicable Relays.

Accessories for DIN Track Mounting (Order Separately)

(Unit: mm)

DIN Tracks

PFP-100N

PFP-50N

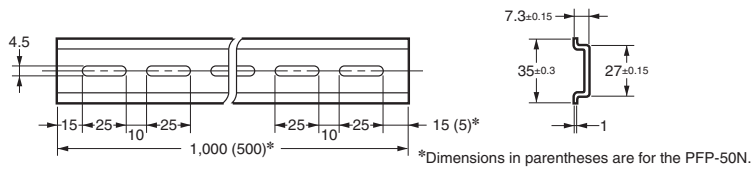
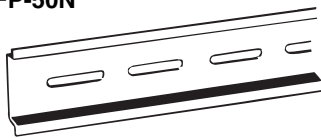

Model
PFP-100N
PFP-50N

DIN Track

PFP-100N2

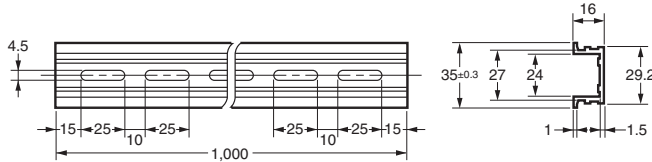
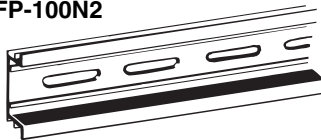

Model
PFP-100N2

End Plate

PFP-M

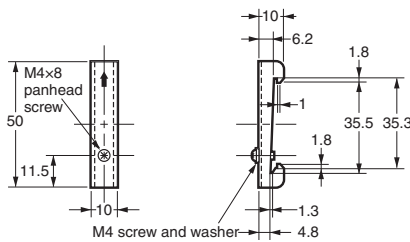
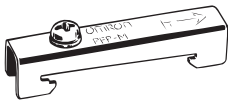

Model
PFP-M

Spacer

PFP-S

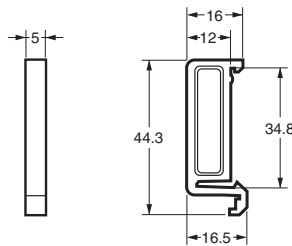
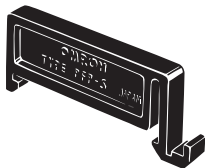

Model
PFP-S

Note: 1. Order the above products in multiples of 10.
2. The Tracks conform to DIN standards.

Features of Screwless Sockets

Structured for Easy Wiring

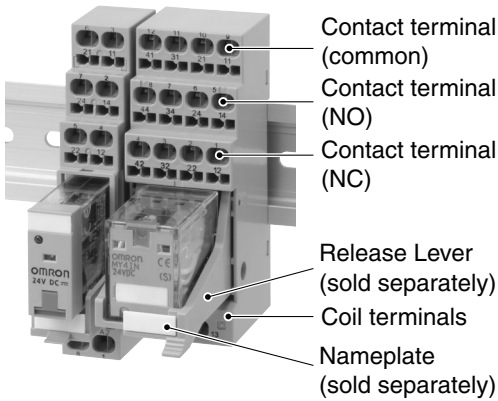

Complete Wiring in Three Steps

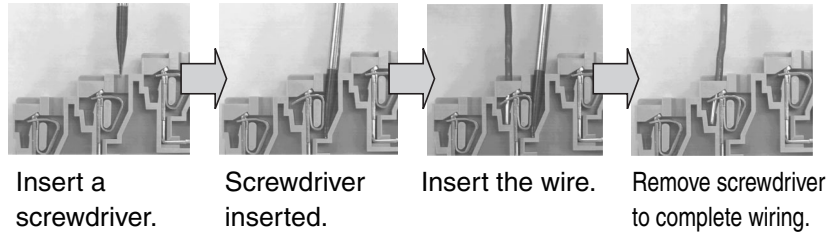

- A spring holds the wire in place to reduce wiring work by 30% (according to OMRON comparison) and eliminates the need to manage torque.
- DIN terminal numbers also indicated.

Safety Precautions

Precautions for Safe Use

- Do not move the screwdriver up, down, or from side to side or rotate it while it is inserted in the hole. Doing so may damage internal components in the Socket.

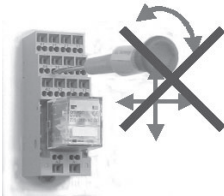

- Do not insert more than one wire into the same hole. Doing so may cause abnormal heating.
- There are two internally connected wiring holes for each terminal.
- Insert the screwdriver along the hole wall as shown below.

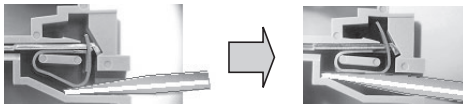

Screwdriver

- When you remove a Socket from a support rail, insert the end of a screwdriver into the fixture and move the driver as shown by the arrow in the following figure.

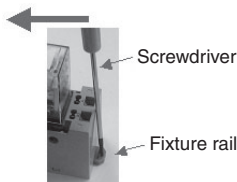

- When you use a Release Lever to remove a Relay from a P2RF-□□-S Socket, insert a screwdriver at the location shown in the following figure and move the Release Lever in the direction indicated by the arrow to release the lock on the release lever.

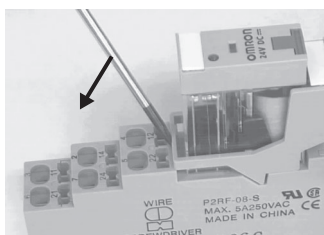

Precautions for Correct Use

Wiring Tools

Applicable Screwdriver

Use a flat-blade screwdriver with a tip that is 2.5 mm wide (3.0 mm max.).

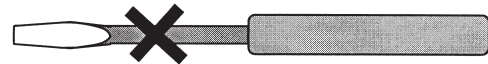
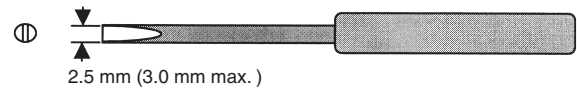

You cannot use a screwdriver with a thick shaft.

Applicable Screwdriver (Example)
VESSEL No.9900 – (–) 2.5 × 75

Applicable Wires

- You can use either solid wires or stranded wires. Applicable wire size: 0.2 to 1.5 mm² (AWG24 to AWG16)
- Strip 8 to 9 mm of insulation from the ends of the wires.

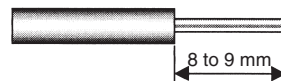

- If you insert stranded wires without ferrules, make sure that the wires are twisted when you insert them.
- If you use bare ferrules, always attach insulating sleeves.
- If you insert a wire with a sheath outer diameter of 2.2 mm or less, do not insert the wire far enough so that the sheath is engaged inside the hole, as shown below.



- Two wires with a sheath outer diameter of 3.2 mm or larger cannot be inserted for the same terminal at the same time.
- Use heat-shrinking tubes to indicate wire numbers.

Wiring

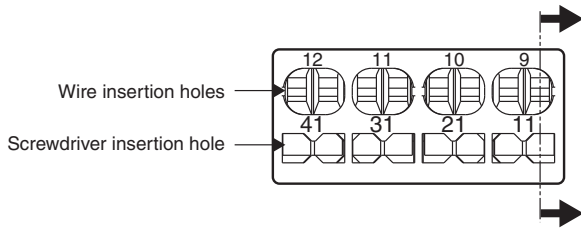

(1) Insert a screwdriver into a screwdriver insertion hole on the Socket.

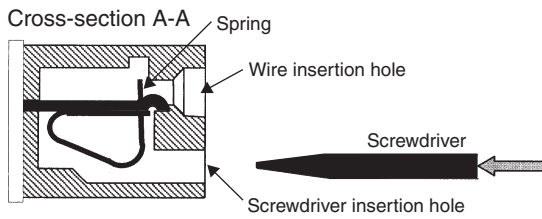

(2) Press the screwdriver in until it reaches the stopper inside the Socket. The spring at the back of the wire insertion hole will be complete open in this condition. The screwdriver will be held in place even if you remove your hand.

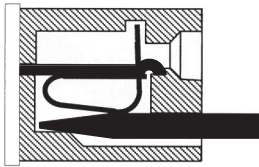

(3) With the screwdriver held in place, insert the wire or ferrule into the wire insertion hole.

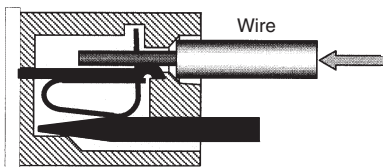

(4) Remove the screwdriver. The spring will hold the wire. This concludes the connection procedure.

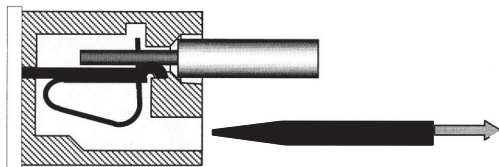

Terms and Conditions Agreement

Read and understand this catalog.

Please read and understand this catalog before purchasing the products. Please consult your OMRON representative if you have any questions or comments.

Warranties.

(a) Exclusive Warranty. Omron's exclusive warranty is that the Products will be free from defects in materials and workmanship for a period of twelve months from the date of sale by Omron (or such other period expressed in writing by Omron). Omron disclaims all other warranties, express or implied.

(b) Limitations. OMRON MAKES NO WARRANTY OR REPRESENTATION, EXPRESS OR IMPLIED, ABOUT NON-INFRINGEMENT, MERCHANTABILITY OR FITNESS FOR A PARTICULAR PURPOSE OF THE PRODUCTS. BUYER ACKNOWLEDGES THAT IT ALONE HAS DETERMINED THAT THE PRODUCTS WILL SUITABLY MEET THE REQUIREMENTS OF THEIR INTENDED USE.

Omron further disclaims all warranties and responsibility of any type for claims or expenses based on infringement by the Products or otherwise of any intellectual property right. (c) Buyer Remedy. Omron's sole obligation hereunder shall be, at Omron's election, to (i) replace (in the form originally shipped with Buyer responsible for labor charges for removal or replacement thereof) the non-complying Product, (ii) repair the non-complying Product, or (iii) repay or credit Buyer an amount equal to the purchase price of the non-complying Product; provided that in no event shall Omron be responsible for warranty, repair, indemnity or any other claims or expenses regarding the Products unless Omron's analysis confirms that the Products were properly handled, stored, installed and maintained and not subject to contamination, abuse, misuse or inappropriate modification. Return of any Products by Buyer must be approved in writing by Omron before shipment. Omron Companies shall not be liable for the suitability or unsuitability or the results from the use of Products in combination with any electrical or electronic components, circuits, system assemblies or any other materials or substances or environments. Any advice, recommendations or information given orally or in writing, are not to be construed as an amendment or addition to the above warranty.

See <http://www.omron.com/global/> or contact your Omron representative for published information.

Limitation on Liability; Etc.

OMRON COMPANIES SHALL NOT BE LIABLE FOR SPECIAL, INDIRECT, INCIDENTAL, OR CONSEQUENTIAL DAMAGES, LOSS OF PROFITS OR PRODUCTION OR COMMERCIAL LOSS IN ANY WAY CONNECTED WITH THE PRODUCTS, WHETHER SUCH CLAIM IS BASED IN CONTRACT, WARRANTY, NEGLIGENCE OR STRICT LIABILITY.

Further, in no event shall liability of Omron Companies exceed the individual price of the Product on which liability is asserted.

Suitability of Use.

Omron Companies shall not be responsible for conformity with any standards, codes or regulations which apply to the combination of the Product in the Buyer's application or use of the Product. At Buyer's request, Omron will provide applicable third party certification documents identifying ratings and limitations of use which apply to the Product. This information by itself is not sufficient for a complete determination of the suitability of the Product in combination with the end product, machine, system, or other application or use. Buyer shall be solely responsible for determining appropriateness of the particular Product with respect to Buyer's application, product or system. Buyer shall take application responsibility in all cases.

NEVER USE THE PRODUCT FOR AN APPLICATION INVOLVING SERIOUS RISK TO LIFE OR PROPERTY OR IN LARGE QUANTITIES WITHOUT ENSURING THAT THE SYSTEM AS A WHOLE HAS BEEN DESIGNED TO ADDRESS THE RISKS, AND THAT THE OMRON PRODUCT(S) IS PROPERLY RATED AND INSTALLED FOR THE INTENDED USE WITHIN THE OVERALL EQUIPMENT OR SYSTEM.

Programmable Products.

Omron Companies shall not be responsible for the user's programming of a programmable Product, or any consequence thereof.

Performance Data.

Data presented in Omron Company websites, catalogs and other materials is provided as a guide for the user in determining suitability and does not constitute a warranty. It may represent the result of Omron's test conditions, and the user must correlate it to actual application requirements. Actual performance is subject to the Omron's Warranty and Limitations of Liability.

Change in Specifications.

Product specifications and accessories may be changed at any time based on improvements and other reasons. It is our practice to change part numbers when published ratings or features are changed, or when significant construction changes are made. However, some specifications of the Product may be changed without any notice. When in doubt, special part numbers may be assigned to fix or establish key specifications for your application. Please consult with your Omron's representative at any time to confirm actual specifications of purchased Product.

Errors and Omissions.

Information presented by Omron Companies has been checked and is believed to be accurate; however, no responsibility is assumed for clerical, typographical or proofreading errors or omissions.